

**SERIES WB 100 – WALL BRACKET JIB CRANES**

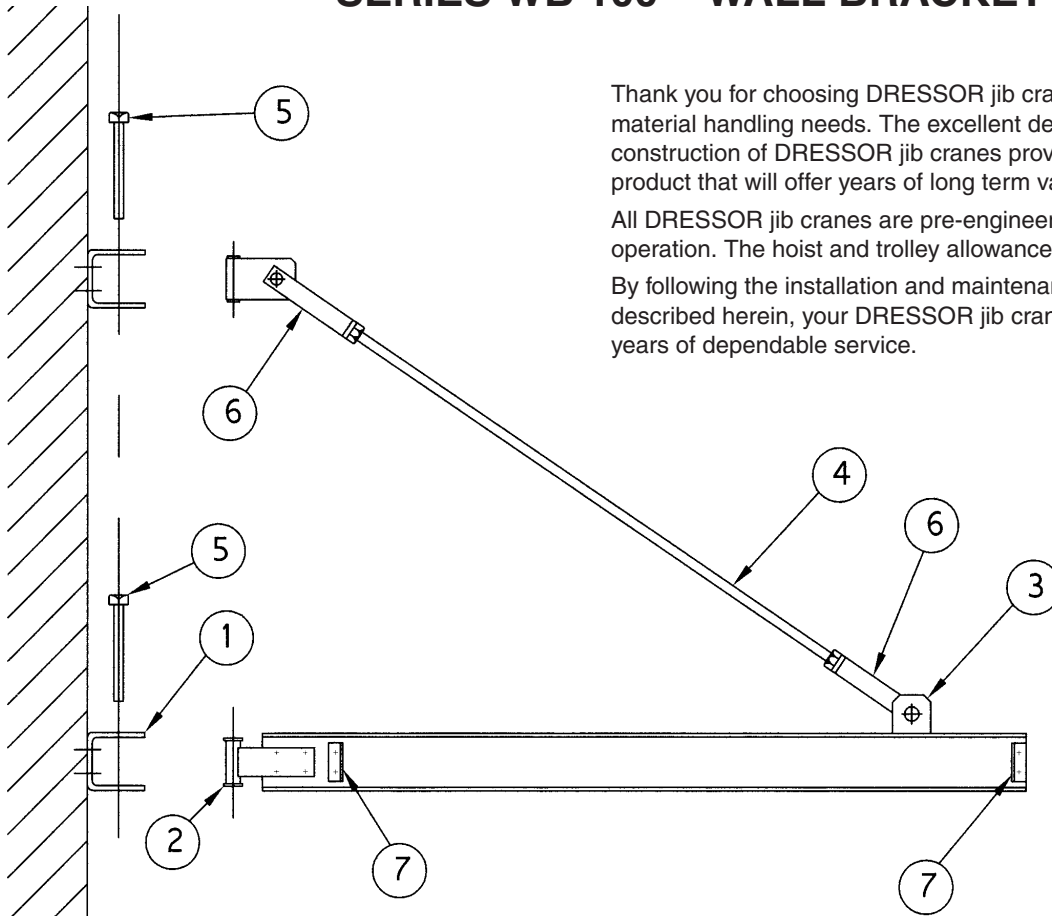

Thank you for choosing DRESSOR jib cranes to solve your material handling needs. The excellent design and heavy duty construction of DRESSOR jib cranes provide a superior quality product that will offer years of long term value.

All DRESSOR jib cranes are pre-engineered for powered hoist operation. The hoist and trolley allowance is 15% of the capacity.

By following the installation and maintenance procedures described herein, your DRESSOR jib crane will provide many years of dependable service.

1. Bolt brackets ① to structurally adequate wall or column (bolts by others - see page 3 for diameter), making sure brackets are in line and plumb through holes for bolts ⑤ .

NOTE: Buyer and user warrants that the structure in which and to which this system or equipment is to be installed is adequate to sustain the loads that will be imposed on it by said system or equipment when it is operating as intended.

2. Bolt brackets ② and ③ to jib beam.
3. Attach tension rod ④ to clevises ⑥ . Two nuts and one lock washer required for each end.
4. Raise boom assembly and attach to lower wall bracket ① using bolt ⑤ supplied.
5. Attach top end of tension rod assembly to top bracket ① and beam bracket ③ – bolts supplied.
6. Level beam by adjusting tension rod.
7. Add hoist and trolley stops ⑦ .

NOTE: Hardware and tie rods are supplied with complete cranes or may be purchased with fitting kits (see page 2 and 3 for fitting kit, hardware kit, and tie rod Product Numbers).

WARNING: Equipment described herein is not designed for, and should not be used for lifting, supporting or transporting humans. Failure to comply with any one of the limitations noted herein can result in serious bodily injury and/or property damage.

SUGGESTED MAINTENANCE	1. LUBRICATION –	Renew grease in upper and lower pivot assemblies every six (6) months with Lubriplate no. 630-AA or equivalent.
	2. ADJUSTMENTS –	Check: Level of boom and tighten all hardware every three (3) months
	3. INSPECTION –	Every six (6) months perform general check

Capacity Tons	Span	Hinge Kit No.	B (a) Bracket Centers	D	W (b) Beam	C Cap Channel Length	Tie Rod Diameter	Tie Rod Length (d)	Thrust and Pull (c) (lbs.)	Net Weight of Crane (Approx. lbs.)	S-Beam Length	
1/2	8'	WB-1	2' - 9"	1' - 3"	6		1"	6' - 1-1/2"	3720	265	7' - 7-3/8"	
	10'		3' - 0"	1' - 6"	6			7' - 10 -1/4"	4420	300	9' - 7-3/8"	
	12'		3' - 9"	1' - 9"	6			9' - 9"	4360	335	11' - 7-3/8"	
	14'		4' - 6"	2' - 0"	6			11' - 7-1/2"	4330	375	13' - 7-3/8"	
	16'		5' - 6"	2' - 6"	6			13' - 10-1/2"	4120	410	15' - 7-3/8"	
	18'		6' - 0"	2' - 0"	7			15' - 11"	4400	495	17' - 7-3/8"	
	20'		6' - 6"	2' - 3"	8			17' - 8-1/2"	4680	600	19' - 7-3/8"	
	22'		7' - 0"	2' - 3"	8c6	18' - 9"			19' - 9-1/4"	5130	905	21' - 7-3/8"
	24'		7' - 6"	2' - 6"	8c6	20' - 6"			21' - 7"	5350	975	23' - 7-3/8"
	26'		8' - 0"	2' - 0"	10c6	22' - 6"			23' - 8-1/2"	5810	1230	25' - 7-3/8"
	28'		9' - 0"	3' - 0"	10c6	24' - 0"			25' - 4-1/4"	5680	1315	27' - 7-3/8"
	30'		10' - 0"	3' - 6"	12c8	25' - 6"			27' - 1"	6040	1710	29' - 7-3/8"
1	8'	WB-1	2' - 9"	1' - 3"	6		1"	6' - 1-1/2"	7280	265	7' - 7-3/8"	
	10'		3' - 0"	1' - 6"	6			7' - 10-1/4"	8620	300	9' - 7-3/8"	
	12'		3' - 9"	1' - 9"	6			9' - 9"	8640	335	11' - 7-3/8"	
	14'		4' - 6"	2' - 0"	7			11' - 7-1/2"	8440	415	13' - 7-3/8"	
	16'		5' - 6"	2' - 3"	7			13' - 7-1/2"	8010	455	15' - 7-3/8"	
	18'		6' - 0"	2' - 6"	8			15' - 5"	8450	555	17' - 7-3/8"	
	20'		6' - 6"	2' - 6"	10			17' - 5-1/4"	8980	745	19' - 7-3/8"	
	22'		7' - 0"	2' - 9"	10c6	18' - 3"			19' - 3-1/4"	9580	1065	21' - 7-3/8"
	24'		7' - 6"	2' - 9"	10c6	20' - 3"			21' - 3-1/4"	9890	1150	23' - 7-3/8"
	26'		8' - 0"	3' - 0"	10c6	22' - 0"			23' - 1-1/2"	10190	1230	25' - 7-3/8"
	28'		9' - 0"	3' - 6"	12c8	23' - 6"			24' - 10-1/4"	10320	1610	27' - 7-3/8"
	30'		10' - 0"	3' - 6"	12c8	25' - 6"			27' - 1"	10100	1710	29' - 7-3/8"
2	8'	WB-2	2' - 9"	1' - 3"	8		1-1/2"	6' - 0-1/2"	14480	375	7' - 7-1/4"	
	10'		3' - 0"	1' - 6"	8			7' - 10'	17170	435	9' - 7-1/4"	
	12'		3' - 9"	1' - 9"	8			9' - 8-1/2"	16790	495	11' - 7-1/4"	
	14'		4' - 6"	2' - 0"	8			11' - 7-1/4"	16590	550	13' - 7-1/4"	
	16'		5' - 6"	2' - 3"	10			13' - 6-1/2"	16880	720	15' - 7-1/4"	
	18'		6' - 0"	2' - 3"	10			15' - 7-1/4"	16570	795	17' - 7-1/4"	
	20'		6' - 6"	2' - 6"	12			17' - 4-1/2"	17320	1000	19' - 7-1/4"	
	22'		7' - 0"	2' - 6"	12c8	18' - 6"			19' - 15-1/2"	18320	1420	21' - 7-1/4"
	24'		7' - 6"	3' - 0"	12c8	20' - 0"			21' - 0-1/2"	18860	1535	23' - 7-3/4"
	26'		8' - 0"	3' - 6"	12c8	21' - 6"			22' - 7-1/4"	19360	1650	25' - 7-1/4"
	28'		9' - 0"	3' - 6"	12c8	23' - 6"			24' - 10"	18720	1760	27' - 7-1/4"
	30'		10' - 0"	3' - 0"	12c8	26' - 0"			27' - 6-1/4"	18220	1895	29' - 7-1/4"
3	8'	WB-3	2' - 9"	1' - 3"	8		1-1/2"	6' - 1-1/4"	21600	435	7' - 6-5/8"	
	10'		3' - 3"	1' - 6"	8			7' - 11"	23550	490	9' - 6-5/8"	
	12'		4' - 0"	1' - 9"	10			9' - 9-1/2"	23570	630	11' - 6-5/8"	
	14'		4' - 9"	2' - 0"	10			11' - 8-1/4"	23530	700	13' - 6-5/8"	
	16'		5' - 6"	2' - 3"	10			13' - 7"	23510	765	15' - 6-5/8"	
	18'		6' - 3"	2' - 3"	12			15' - 8-1/4"	23680	950	17' - 6-5/8"	
	20'		7' - 0"	2' - 6"	12c8	16' - 6"			17' - 7-1/4"	24060	1340	19' - 6-5/8"
	22'		7' - 9"	2' - 6"	12c8	18' - 6"			19' - 9"	14240	1450	21' - 6-5/8"
	24'		8' - 6"	3' - 0"	12c8	20' - 0"			21' - 5"	24220	1565	23' - 6-5/8"
	26'		9' - 3"	3' - 0"	12c8	22' - 0"			23' - 6-1/2"	24310	1940	25' - 6-5/8"
	28'		10' - 0"	3' - 0"	12c8	24' - 0"			25' - 8"	24410	2065	27' - 6-5/8"
	30'		11' - 0"	3' - 0"	12c8	26' - 0"			27' - 10-1/2"	23950	2185	29' - 6-5/8"
5	8'	WB-5	3' - 0"	1' - 6"	12		2"	5' - 10-1/4"	33000	780	7' - 6-1/4"	
	10'		3' - 3"	1' - 6"	12			7' - 10'	39260	860	9' - 6-1/4"	
	12'		4' - 0"	1' - 9"	12			9' - 7"	39070	940	11' - 6-1/4"	
	14'		4' - 9"	2' - 0"	12			11' - 7-1/2"	38970	1020	13' - 6-1/4"	
	16'		5' - 6"	2' - 6"	15			13' - 3"	39180	1280	15' - 6-1/4"	
	18'		6' - 3"	3' - 0"	15			14' - 11"	39150	1385	17' - 6-1/4"	
	20'		7' - 0"	3' - 6"	15c10	15' - 3"			16' - 7"	39660	1755	19' - 6-1/4"
	22'		7' - 9"	3' - 6"	15c10	17' - 3"			18' - 8-1/2"	39740	1885	21' - 6-1/4"
	24'		8' - 6"	3' - 6"	15c10	19' - 3"			20' - 10-1/4"	39850	2015	23' - 6-1/4"
	26'		9' - 3"	3' - 6"	15c10	21' - 3"			23' - 0"	39960	2145	25' - 6-1/4"
	28'		10' - 0"	3' - 6"	15c10	23' - 3"			25' - 1-1/2"	40070	2690	27' - 6-1/4"
	30'		11' - 0"	3' - 6"	15c10	25' - 3"			27' - 4-1/4"	39280	2835	29' - 6-1/4"
SPECIAL												

- (a) Do not deviate from "B" dimension
- (b) The "W" dimension indicates the size S-beam to be used. If a cap channel needs to be stitch welded to the top of the S-beam, the letter "C" will follow the S-beam size. The last number indicates the size of the cap channel.
- (c) The diagram to the right, details the thrust and pull forces that this jib crane applies to the supporting structure when a load is lifted. The chart above details in pounds the thrust at point T and the pull at point P. It is essential that a structurally adequate wall, column or truss exist to support the jib crane.
- (d) One tie rod required per crane. Tie rods threaded 6 inches on each end.

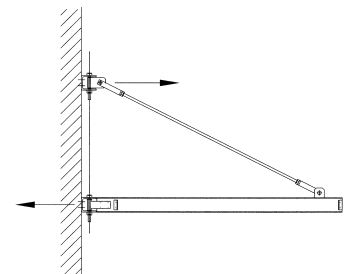

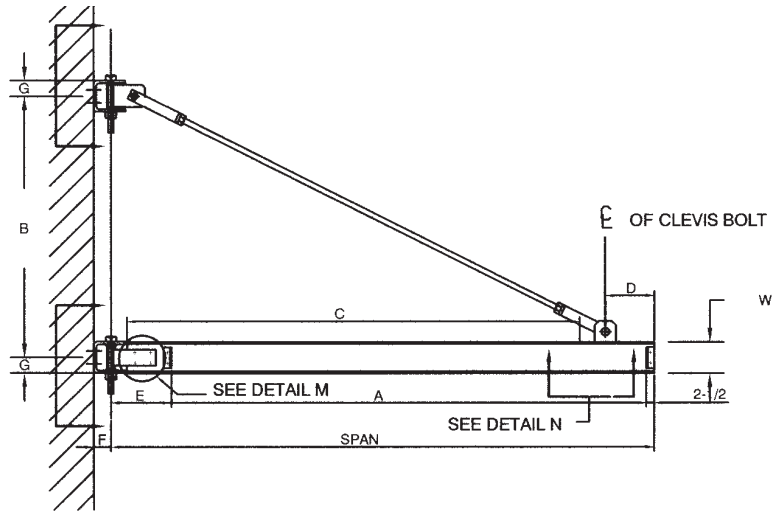

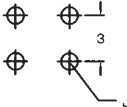
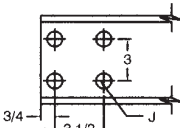
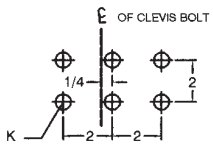
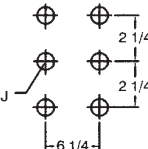
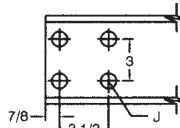
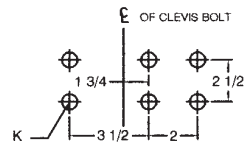
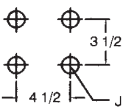
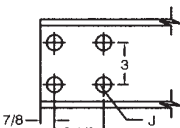
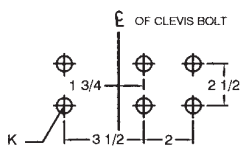
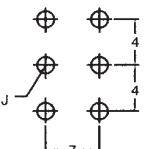
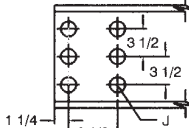
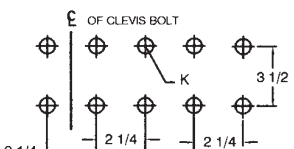
<p style="text-align: center;"><b>WB-1</b></p> <p>DETAIL L</p>  <p>A= SPAN-16      E= 13-1/2  F= 3-1/2      G= 3-1/2  J= 5/8" BOLTS      K= 1/2" BOLTS  M AND N HARDWARE KIT NO. 4110110  TIE ROD NO. 4110210 (SPECIFY LENGTH)</p>  <p style="text-align: center;">DETAIL M</p>  <p style="text-align: center;">DETAIL N</p>	<p style="text-align: center;"><b>WB-3</b></p> <p>DETAIL L</p>  <p>A= SPAN-16-1/2      E= 14  F=4      G= 4-5/8  J= 3/4" BOLTS      K= 5/8" BOLTS  M AND N HARDWARE KIT NO. 4110130  TIE ROD NO. 4110230 (SPECIFY LENGTH)</p>  <p style="text-align: center;">DETAIL M</p>  <p style="text-align: center;">DETAIL N</p>
<p style="text-align: center;"><b>WB-2</b></p> <p>DETAIL L</p>  <p>A= SPAN-16      E= 13-1/2  F= 4      G= 4-1/8  J= 3/4" BOLTS      K= 5/8" BOLTS  M AND N HARDWARE KIT NO. 4110120  TIE ROD NO. 4110220 (SPECIFY LENGTH)</p>  <p style="text-align: center;">DETAIL M</p>  <p style="text-align: center;">DETAIL N</p>	<p style="text-align: center;"><b>WB-5</b></p> <p>DETAIL L</p>  <p>A= SPAN-17-3/4      E= 15-1/4  F=6      G= 7  J= 1-1/4" BOLTS      K= 3/4" BOLTS  M AND N HARDWARE KIT NO. 4110150  TIE ROD NO. 4110250 (SPECIFY LENGTH)</p>  <p style="text-align: center;">DETAIL M</p>  <p style="text-align: center;">DETAIL N</p>

All dimensions are in inches.  
Hardware for Detail L by others.

## Wall Bracket Jib Crane Kit Pricing

CAP. TONS	MODEL NUMBER	LIST PRICE	WEIGHT	TIE ROD LIST PRICE
1	WB-1	\$575	111#	\$75 + \$4.64/lin.ft.
2	WB-2	\$775	133#	\$75 + \$5.75/lin.ft.
3	WB-3	\$1085	195#	\$75 + \$8.75/lin.ft.
5	WB-5	\$2525	425#	\$75 + \$12.75/lin.ft.

DISTRIBUTED BY